







25 023 360



- 160mm projection
- Hand shower: COMPACT RAIN, max. flow rate 7.6 l/min (at 3 bar)
- spout: rectangular normal flow
- wall bracket
- rotary diverter for bath/shower
- rosette Ø 70 mm
- 1/2" connection
- gauge 153 mm
- metal shower hose 1250mm with integrated anti-twist protection
- max. spout flow rate 26 l/min

Note: Local building codes may require the use of an anti-scald device. Please refer to remote pressure balance valve (35 910 970 90)

Intrinsic protection against back flow.

	Chrome	25 023 360-00 0010
	Brushed Platinum	25 023 360-06 0010
	Platinum	25 023 360-08 0010
	Durabress (23kt Gold)	25 023 360-09 0010
	Brushed Durabress (23kt Gold)	25 023 360-28 0010
	Brushed Dark Platinum	25 023 360-99 0010

25 023 360

mm [inches]

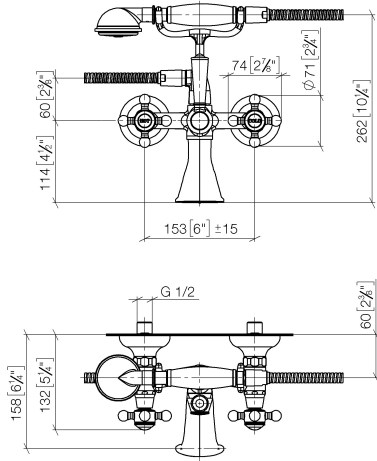

Flow rate chart

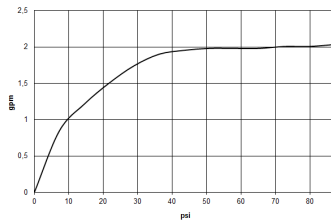

Codes & Standards

California Energy
Commission
(CEC)

25 023 360

Parts for other finishes can be found here: [Brushed](#)
[Platinum](#)

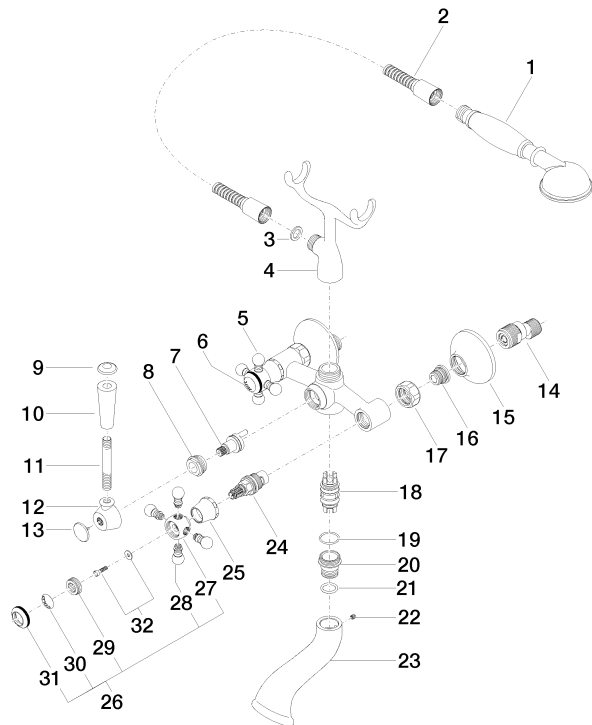

25 023 360

Spare parts list

No.	Item Number	Name	Quantity used	Delivery time
1	28 002 970-00 0010	MADISON Metal hand shower with porcelain insert (white) FlowReduce - Chrome	1	10
2	28 104 970-00	Metal shower hose 1/2" x 1/2" x 1250 mm - Chrome	1	2
3	90 14 20 002 00 90	seal	1	2
4	04 17 20 010 00-00	holder	1	10
5	04 20 36 002 07-00	handle (hot)	1	10
6	09 26 01 011 90	accessories	1	2
7	90 15 01 001 00 90	diverter	1	2
8	09 23 10 007 90	nut	1	2
9	09 30 30 062-00	screw	1	10
10	11 170 370-00	MADISON Lever insert - Chrome	1	10
11	09 28 22 013 90	pipe	1	2
12	09 18 20 011-00	base	1	10
13	09 30 30 064-00	screw	1	10
14	04 11 04 030 00 90	connection	2	2
15	09 27 39 010-00	rosette	2	10
16	04 29 05 014 00 90	nipple	2	2
17	09 23 30 010-00	nut	2	10
18	90 21 10 010 00 90	insert	1	2
19	90 14 10 056 00 90	seal	1	2
20	09 24 03 123 20 90	nipple	1	2
21	09 14 10 022 90	seal	1	2
22	90 31 11 030 00 90	pin	1	2
23	09 11 06 033 20-00	spout	1	10
24	90 90 03 131 00 90	top	2	2
25	09 21 02 055-00	cover	2	10
26	04 20 36 002 06-00	handle (cold)	1	10
27	09 20 36 002-00	handle	2	10
28	09 20 36 004-00	handle	8	10
29	09 20 83 006 90	handle	2	2
30	09 26 01 010 90	accessories	1	2
31	09 20 36 005-00	handle	2	10
32	04 30 30 029 00 90	fixing set	2	2